

Translation of the original operating instructions

EN

VD 500

| FLOW |



The completeness and accuracy of this documentation have been carefully checked. We reserve the right to make technical changes at any time. These changes may result in deviations from the information provided in this documentation.

The original document was published in the manufacturer's national language (German). All translations are copies of the original document and are only valid in conjunction with the original.

All rights reserved.

© 2026 CS INSTRUMENTS GmbH & Co. KG

Edition and revision status: 02/2026 | V2.01 | 020001752



Table of contents

1	General information	5
1.1	Documentation	5
1.2	Symbols and labels used	5
1.3	Safety instructions and notes	5
2	Security	6
2.1	Intended use	6
2.2	Organizational measures of the operator.....	7
2.3	Residual risks.....	7
3	VD 500	9
3.1	Product overview.....	9
3.2	Product description	9
3.3	Type plate.....	9
3.4	Scope of delivery.....	9
3.5	Applicable documents	10
4	Transportation and storage	11
4.1	Delivery	11
4.2	Storage.....	11
5	Installation and commissioning	12
5.1	General installation instructions	12
5.2	Set up measuring point	14
5.3	Assemble product	15
5.4	Complete the installation work	16
5.5	Connect product.....	16
5.6	Initial commissioning	19
5.7	Switching on and off.....	20
6	Operation	21
6.1	Control elements	21
6.2	User interface.....	21
7	Configuration	22
7.1	Set up basic settings	22
7.2	Adjust configuration settings	23
7.3	Set interface parameters.....	26
7.4	Set output parameters.....	29
8	Consumption measurement	31
8.1	Adjust measurement parameters	31
8.1.1	Carry out zero point adjustment.....	31
8.1.2	Adjust creep suppression.....	32
8.2	Carry out consumption measurement.....	33
9	Maintenance and servicing	34
9.1	Clean product.....	34
9.2	Check cables.....	34
9.3	Check mechanical components and connections.....	35
9.4	Perform calibration	35



9.5	Update software	36
9.5.1	Download software package	36
9.5.2	Establish connection	36
9.5.3	Performing a software update	36
9.6	Error states	36
9.6.1	Correct error states	36
9.6.2	Restore factory settings	37
9.7	Customer service	38
10	Decommissioning and disposal	39
11	Appendix	40
11.1	Technical data	40
11.2	Dimensions.....	41
11.3	Measuring ranges	41
11.4	Register assignment	43
11.5	Declaration of conformity	45



1 General information

For the sake of simplicity, this documentation refers to the product "VD 500" simply as the **product**.

1.1 Documentation

This documentation provides important warnings, safety precautions, and instructions for the safe and proper operation of the product.

- ▷ Before operating the product, read this documentation carefully and ensure that you fully understand its contents.
- ▷ Always keep this documentation readily available for reference purposes.

1.2 Symbols and labels used

The following markings and symbols are used in this documentation:







Labeling/symbol	Usage
Text	Important text passages are highlighted
text	Control elements VD 500
Text	Software user interface
Text > Text > Text	User interface click path
 2 Security	Cross-reference to text passage, figure or chapter
•	Enumeration, list element
▷	Call to action as part of an instruction. Can also be numbered.
✓	Final or intermediate result of an action instruction
✗	Final or intermediate result of an instruction that has not been achieved
! (in a circle)	Note on an intermediate result

Table 1: Symbols and labels used

1.3 Safety instructions and notes

	DANGER Indicates an imminent danger. Death or very serious injuries may result.
	WARNING Indicates a potentially dangerous situation. Death or serious injury may result.
	CAUTION Indicates a potentially dangerous situation. Slight or minor injuries may result.
	NOTICE Indicates a potentially dangerous situation. Material or environmental damage may result.
	NOTE Indicates important information, application tips, and useful information for proper working.

2 Security

The product has been designed, manufactured, and functionally tested in accordance with applicable safety regulations.

To ensure operational safety, please observe the following:

- Chapter "Intended use"
- Chapter "Organizational measures to be taken by the operator"
- Chapter "Residual hazards"

Regardless of the instructions provided in this manual, all applicable country-specific occupational health and safety regulations must be observed.

2.1 Intended use

The operational safety of the product supplied is only guaranteed if it is used as intended.

The product enables continuous flow measurement based on the dynamic pressure or differential pressure principle.

The product can be configured to measure a defined selection of pure gases or gas mixtures. It enables the consumption measurement of gases such as air (including humid compressed air) and technical gases. In the explosion-proof version (Ex), it is also possible to measure explosive gases, e.g. methane (natural gas), propane and hydrogen.

Intended use exists in particular if

- the installation is carried out exclusively downstream of a functioning water separator,
- the measuring sensors of the product are aligned exactly with the center of the pipe,
- the installation is carried out in horizontal pipes (recommended) or in vertical risers,
- the product is correctly positioned,
- an undisturbed flow is ensured by maintaining the required calming distances upstream and downstream of the sensor,
- the product is operated within the specified pressure range,
- the permissible operating temperature is observed,
- the zero point adjustment is carried out correctly and the relevant measurement parameters and the flow medium are specified and
- calibration and maintenance are carried out regularly by qualified personnel.

Any use outside these framework conditions, in particular if the pressure or temperature is exceeded or if liquids or hazardous substances are introduced, is considered improper use and can lead to malfunctions or irreversible damage.

Any use beyond or deviating from this is considered improper use. The manufacturer accepts no liability for any resulting damage.

Intended use also includes:

- Adherence to the supplied documentation
- Compliance with all inspection and maintenance requirements specified by the manufacturer

Reasonably foreseeable misuse or improper handling are:

- Contact with liquids
- Contact with steam, aggressive gases or hazardous substances
- Use as a climbing aid
- Operation outside the technical specifications
- Tampering with the product in any way that does not comply with the intended and described procedures
- Standard version: Use in potentially explosive atmospheres



2.2 Organizational measures of the operator

The product may only be used if it is in perfect technical condition. It may no longer be used if it has been technically modified or damaged.

Instructions

The information on commissioning, operation, and maintenance provided in these instructions must be followed. These instructions should always be kept accessible with the product.

Personnel

People working on the product must read these instructions, particularly the chapter entitled " 2 Security", before starting work. This also applies to people who only work occasionally.

2.3 Residual risks



DANGER

Risk of injury due to insufficiently qualified personnel

Improper handling of the product can lead to serious personal injury and damage to property. All work described in these instructions may only be carried out by qualified specialists.

Qualified personnel are persons with appropriate training and in-depth knowledge of measurement, control, regulation and compressed air technology. They must also be familiar with the applicable national regulations, standards and directives and be able to assess risks independently.



DANGER

Injury or death from touching live parts

When carrying out installation and maintenance work, you may encounter parts that carry dangerous voltages during operation. Touching live parts can lead to death.

- ▷ Work on electrical systems or equipment may only be carried out by qualified electricians or by instructed persons under the direction and supervision of a qualified electrician in accordance with electrotechnical regulations.



DANGER

Danger due to overpressure or incorrect installation

The operating pressure in the pipe depends on the application. At pressures above 16 bar, there is an increased risk of injury due to sudden escaping pressure medium.

- ▷ Only operate the product within the permissible limit values.
- ▷ Observe the end values of the upper range values.



DANGER

Danger from escaping compressed gas

Contact with escaping pressurized gas or unsecured system parts can lead to serious injury or death.

- ▷ Only carry out installation and maintenance work when the system is depressurized.
- ▷ Only use pressure-resistant installation material and suitable tools that are in perfect working order.
- ▷ Before pressurizing, check all system parts and tighten all screw connections.
- ▷ Always open valves slowly to avoid pressure surges.
- ▷ Install compressed air lines tightly.
- ▷ Ensure that people and objects cannot come into contact with escaping compressed gas.
- ▷ Avoid transmitting vibrations, oscillations and shocks to the product.
- ▷ Carry out a leak test of the system before commissioning.

**WARNING****Danger during operation outside the specified limit values**

Exceeding or falling below the permissible operating, storage or transportation limits can endanger people and property. There is a risk of malfunctions and operating faults as well as falsified measurement results.

- ▷ Only operate the product within the limit values specified on the rating plate and in the technical data.
- ▷ Observe the permissible storage and transportation conditions.

**WARNING****Risk of injury due to unauthorized modifications**

Unauthorized device modifications can cause injuries and lead to the loss of the operating permit. Operation is only permitted with original components.

- ▷ Unauthorized modifications are not permitted and lead to the exclusion of any warranty and liability by the manufacturer (CS INSTRUMENTS).

**CAUTION****Danger due to malfunction of the product**

Incorrect installation or inadequate maintenance can lead to malfunctions that impair the function of the product and can lead to dangerous misinterpretations.

- ▷ Observe all applicable national regulations and safety regulations during installation and operation.

**CAUTION****Risk of burns due to heated sensor shaft**

Hot air, gases or gas mixtures in the pipe can heat up the sensor shaft considerably.

- ▷ Only touch the sensor shaft when it has cooled down.
- ▷ Wear suitable protective gloves if necessary.

**NOTICE****Measuring errors due to dirt particles in the compressed air**

Dirt particles and fluids can contaminate the product and lead to a malfunction or fault.

- ▷ The system operator must ensure the prescribed purity of the fluids approved for the application as well as appropriate cleaning and maintenance intervals.
- ▷ The manufacturer (CS INSTRUMENTS) accepts no warranty or liability for incorrect use.



3 VD 500

3.1 Product overview

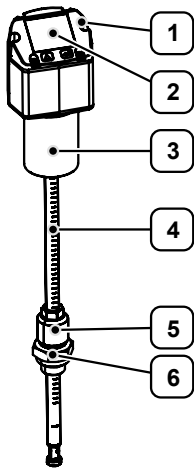

Figure 1: VD 500 (example)

- | | | | |
|---|----------------------|---|-----------------|
| 1 | Housing | 4 | Sensor shaft |
| 2 | Display | 5 | Clamping sleeve |
| 3 | Pressure sensor head | 6 | Connecting nut |

3.2 Product description

The product is a flow sensor for continuous measurement of flow, consumption, temperature and pressure in gas lines. It is designed for use in compressed air and gas mixtures and provides reliable measurement results even under humid operating conditions.

The housing protects the product from environmental influences and allows it to be used in different operating environments. Integrated temperature and pressure compensation automatically takes into account the influencing variables of the operating conditions.

The product can be integrated into pipes of various sizes and installed in both horizontal and vertical pipes. Typical applications include consumption measurement in compressed air systems, compressor performance monitoring and efficiency analyses in gas and compressed air networks.

3.3 Type plate

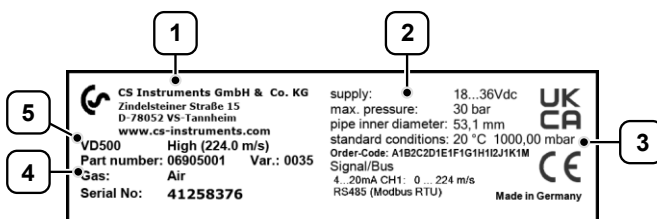

Figure 2: Nameplate (example)

- | | | | |
|---|----------------------------------|---|------------------------|
| 1 | Manufacturer information | 4 | Material/serial number |
| 2 | Technical data | 5 | Product designation |
| 3 | Conformity/certification marking | | |

3.4 Scope of delivery

The scope of delivery includes the following components:

- VD 500
- Positioning key

- 120 Ω resistor
- Calibration certificate
- Translation of the original operating instructions

3.5 Applicable documents

This Translation of the original operating instructions contains information on the operation of the product "VD 500". This essentially includes information such as

- Installation and commissioning
- configuration
- Maintenance and servicing



NOTE

In addition to the basic registers, the device provides further registers. Further information on this can be found in the "Operating instructions - Modbus installation".



4 Transportation and storage



NOTE

Improper transportation, storage and commissioning are accident-prone and can cause damage or malfunctions to the delivered product, for which the manufacturer (CS INSTRUMENTS) does not grant any liability or warranty.

4.1 Delivery

Transport damage

- ▷ Check the delivered components for any visible transportation damage.
- ▷ Report any transportation damage to the following parties immediately:
 - the carrier
 - the manufacturer's customer service (CS INSTRUMENTS)
- ▷ Ensure that the product is handled properly during transportation.

Packaging

- ▷ Keep the original packaging for any future transportation or storage.

4.2 Storage

To avoid damage due to environmental influences, the product must be stored properly when not in use.

- ▷ If possible, store the product in its original packaging.
- ▷ Store the product in dry, dust-free rooms.
- ▷ Keep the product away from direct sunlight, heat sources, and corrosive or aggressive chemicals.

5 Installation and commissioning



DANGER

Risk of injury due to pressurized components

Escaping medium can cause serious injuries.

- ▷ To minimize potential hazards, do not work directly above the product, but to the side of it.
- ▷ Secure the housing by hand during assembly and disassembly.



CAUTION

Danger from commissioning a damaged product

If a damaged product is installed or put into operation, it may result in functional failures, electrical hazards, or mechanical risks.

- ▷ Before each start-up, inspect the product, accessories, and all supply lines for visible damage, loose parts, or missing components.
- ▷ Immediately take any defective product out of operation immediately.

5.1 General installation instructions



DANGER

Danger due to overpressure or incorrect installation

The operating pressure in the pipe depends on the application. At pressures above 16 bar, there is an increased risk of injury due to sudden escaping pressure medium.

- ▷ Only operate the product within the permissible limit values.
- ▷ Observe the end values of the upper range values.



WARNING

Danger due to system pressure

Even at low system pressures (from 2-3 bar), there is a risk of injury due to uncontrolled escaping pressure medium.

The following also applies for operating pressures > 10 bar:

- ▷ Use elastomer sealing rings with metal backing.
- ▷ Use a high-pressure safety device.



CAUTION

Observe the process connection

To ensure safe and reliable operation of the product, the following points must be observed when connecting the process:

- ▷ **Ease of maintenance:** Install an oil and grease-free shut-off valve between the product and the process to facilitate maintenance work.
- ▷ **Protection of the product:** Avoid unprotected installation, as liquid or solid impurities can be deposited in the product and permanently impair the measuring accuracy.
- ▷ **Compressed air quality:** Only use clean compressed air without harmful components such as explosive or chemically unstable gases, acids, bases, oils or condensate.
- ▷ **Seals/sealants:** Only use correctly dimensioned seals/sealants that are suitable for the flow medium and meet the required compressed air quality. Permissible sealants are, for example, sealing rings made of copper or aluminum, elastomer sealing rings with metal backing, sealing tape or sealing cord as well as other equivalent sealants.
- ▷ **Installation location:** Avoid installation locations where water can accumulate.



NOTICE

Incorrect measurement results due to condensation or water droplets on the sensor element

- ▷ Avoid installation locations where water can accumulate.
- ▷ Avoid installation below the measuring point, as liquid media could penetrate the device and damage it in the event of a fault.
- ▷ **Do not** install the product with the measuring probes facing upwards, as condensate or water cannot drain away.
- ▷ **Do not** install the product in a downpipe. Installation in a rising pipe is generally possible.

Observe installation location and flow pattern



NOTICE

Measurement deviations due to disturbed flow pattern

The required inlet and outlet distances must be observed to ensure an undisturbed flow pattern.

- ▷ Avoid diameter jumps at the joints of the pipe (max. 1 mm).
- ▷ For further information, see ISO 14511:2019-01.

The measurement result can be influenced by flow disturbances. For the specified accuracies, the product must be installed centrally in a straight pipe section. An undisturbed flow path requires sufficiently long, straight inlet and outlet sections without edges, seams or bends.

- ▷ When positioning the product, observe the required inlet and outlet sections to ensure precise measurement results.

ⓘ If these distances are shortened, increased measurement deviations must be expected. It is therefore **essential** to avoid shortening the calming distances.

	Flow obstacle	Inlet section (L1)	Outlet section (L2)
1	Low curvature (bend < 90°)	12 x DN	5 x DN
2	Reduction (pipe narrows towards the measuring section)	15 x DN	5 x DN
3	Expansion (pipe expands towards the measuring section)	15 x DN	5 x DN
4	90° bend / T-piece	15 x DN	5 x DN
5	2 x bend (90°) 1-dimensional change of direction	20 x DN	5 x DN
6	2 x bends (90°) 3-dimensional change of direction	35 x DN	5 x DN
7	Shut-off valve	45 x DN	5 x DN

Table 2: Required minimum lengths

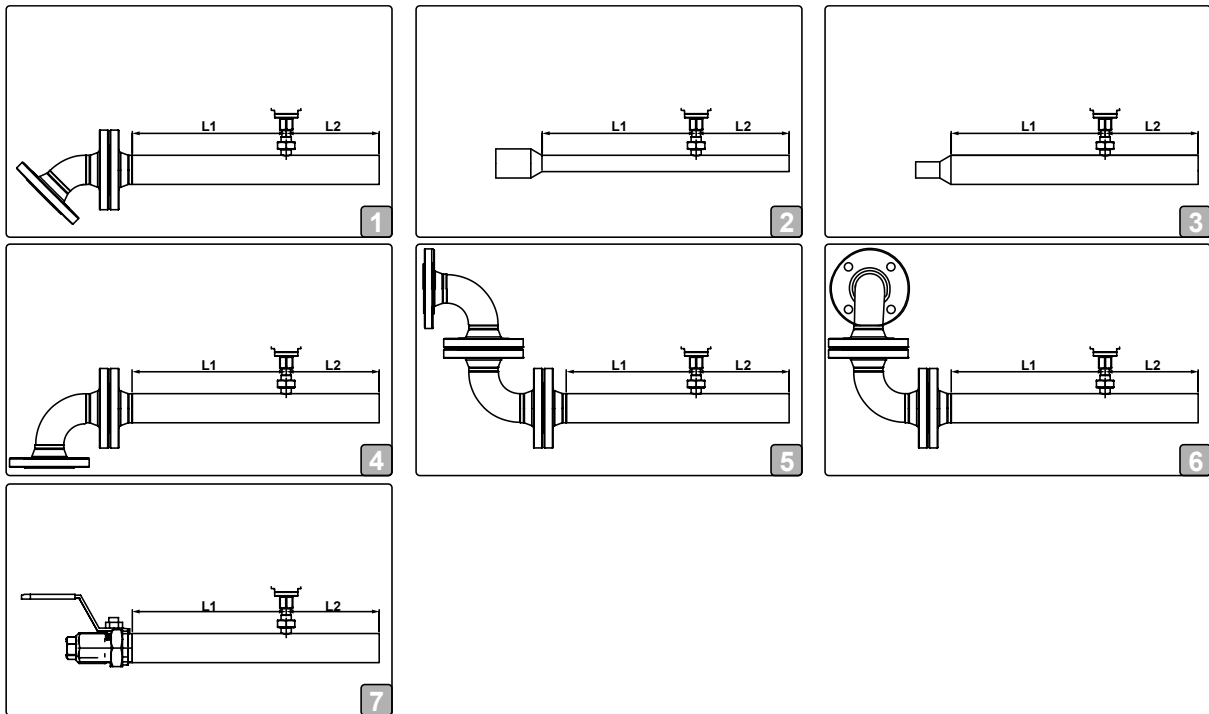

Figure 3: Flow obstacles in front of the measuring section (example)

5.2 Set up measuring point

Setting up the measuring point

The sensor is installed via a ball valve. For the specific design of the mounting thread, see chapter "11.1 Technical data".

- ▷ Select a suitable installation location for the measuring point.
- ▷ Set up the measuring point correctly.
 - ⓘ Contact customer service if the system cannot be depressurized to set up the measuring point.
 - ⓘ Use stainless steel piping for the connection.
- ▷ Check the installation for leaks and a secure fit.



NOTE

If no suitable measuring point with ball valve is available, the following options are available for setting up a measuring point:

- Weld-on socket with ball valve
- Tapping clamp with ball valve (Further information on this can be found in the "Installation instructions - Tapping clamp").

Note the installation angle for potential water occurrence

The product must only be installed downstream of a functioning water separator. If water is nevertheless present, the specified installation angle must be observed.

- ▷ Install the product at an angle of **at least 15°**.
 - ⓘ If the installation angle is $> 15^\circ$, condensate or water may drip off.

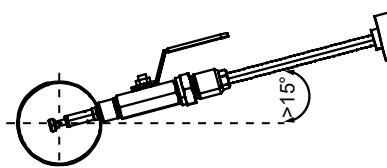

Figure 4: Installation angle of potential water occurrence (example)



5.3 Assemble product

Installing the sensor

- ▷ Close the ball valve.
- ▷ Check that the retaining ring attached to the sensor head is undamaged and correctly fitted.
- ▷ Slide the connecting nut completely over the sensors.
 - ⓘ Take care not to damage the retaining ring or the sensors.
- ▷ Provide the mounting thread with suitable sealing material that matches the flow medium.
- ▷ Screw the sensor (SW 32) pressure-tight into the ball valve.
- ▷ Tighten the connection nut.
 - ⓘ Tightening torque: 25-30 Nm
 - ⓘ **Caution:** The sensor shaft is not yet fixed.

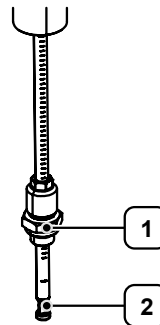

Figure 5: Fitting the sensor (example)

- 1 Connection nut
- 2 Circlip

Aligning the sensor

Before fixing the sensor, the insertion depth and the angular position must be set correctly.

Tools

- Positioning key
- ▷ Push the sensor shaft in towards the center of the pipe.
- ▷ Set the sensor probes to the center of the pipe.
 - ⓘ **Insertion depth = X + Y**
(X= 0.5*OD; Y= length of ball valve; OD= outside diameter)
- ▷ To ensure correct measured values, align the sensor with a **maximum** angular deviation of **±2°**.
 - ⓘ Reference point = tip of positioning key
 - ⓘ Measurement inaccuracies are to be expected if the alignment is imprecise.
- ▷ Observe the direction of flow indicated on the product (direction arrow flow direction).
 - ⓘ Depending on the product variant, the direction arrow is attached as a sticker on the measuring section, on the housing or on the sensor shaft.
- ▷ Tighten the clamping sleeve (SW 17).
 - ⓘ Tightening torque: 25-30 Nm
 - ⓘ The alignment of the sensor must not be changed when tightening. If the alignment does change, check the setting depth and alignment again and correct them if necessary.

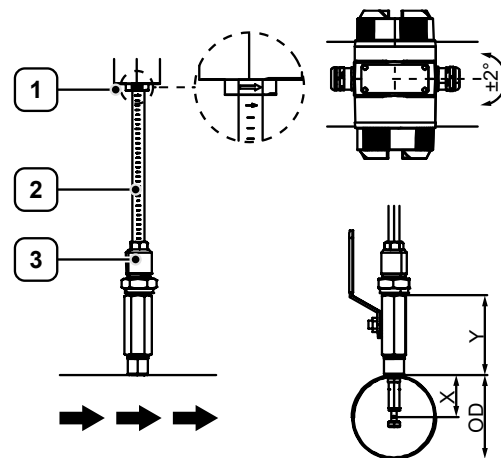

Figure 6: Aligning the sensor (example)

- 1 Direction arrow flow
- 2 Depth scale
- 3 Clamping sleeve

5.4 Complete the installation work

Aligning the sensor housing

The housing cover can be rotated by 180°, e.g. when the flow direction is reversed.

- ▷ Loosen the screws.
- ▷ Rotate the housing cover by 180°.
- ▷ Refit the screws.
- ▷ Ensure that the seals are seated correctly to avoid leaks and malfunctions.
 - ⓘ If necessary, the display can be rotated using the software. Further information can be found in chapter "→ 7.1 Set up basic settings".

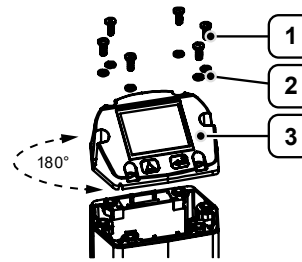

Figure 7: Rotating the housing cover (example)

- 1 Screw (6x)
- 2 Seal (6x)
- 3 Housing cover



CAUTION

Incorrect assembly

Interrupted plug connections or leaks can lead to malfunctions. Incorrect installation can invalidate the operating license.

- ▷ Ensure that all connecting cables are plugged in and the seal is fitted correctly.

Check installation

- ▷ After installation, check the pressure-tight installation of the sensor.
- ▷ Ensure that the pipework is clean after installation.

5.5 Connect product



DANGER

Danger to life due to electrical voltage

During installation, maintenance or in the event of a fault, touchable conductive parts can carry dangerous voltages. Contact with uninsulated parts or mains voltage can lead to serious injury or death.

- ▷ Do not operate the product if power supply cables are damaged or housing parts are defective or removed.
- ▷ Strictly observe all locally applicable regulations and safety regulations.
- ▷ Only carry out work on electrical connections when the power supply is switched off. Secure the product against unintentional restarting.
- ▷ Check all electrical connections before commissioning and regularly during operation.



DANGER

Injury or death from touching live parts

When carrying out installation and maintenance work, you may encounter parts that carry dangerous voltages during operation. Touching live parts can lead to death.

- ▷ Work on electrical systems or equipment may only be carried out by qualified electricians or by instructed persons under the direction and supervision of a qualified electrician in accordance with electrotechnical regulations.



NOTICE

Wiring - general notes

- ▷ Keep stripping lengths as short as possible.
- ▷ Close unused cable entries with end caps.
- ▷ Use shielded connection cables.
- ▷ Use cables with a cross-section $\geq 0,25 \text{ mm}^2$.
- ▷ Tightening torque for cap nut (cable gland): **9 Nm**



NOTICE

Permissible loads and voltages

- The permissible loads and voltages must be observed when connecting. Failure to do so may result in damage to the connection or malfunctions.
- ▷ Observe the permissible loads and voltages when connecting.
 - ▷ Further information can be found in chapter "11.1 Technical data".

Connecting the product electrically



CAUTION

Danger due to unintentional electrical connection

- Unused connections (Not Connected (NC)) must not be connected to potential or earth.
- ▷ Cut off unused cables and insulate them securely.



CAUTION

Communication faults or failure of data transmission

- If the product is used at the end of a Modbus system, termination is required.
- ▷ Activate the termination using the DIP switch.

Setting the termination

- ▷ Remove the housing cover.
- ▷ Set the internal DIP switch to "ON".
- ▷ Fit the housing cover.
- ▷ Ensure that the seals are seated correctly to prevent leaks and malfunctions.

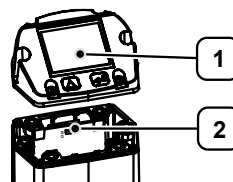

Figure 8: Setting the termination (example)

- 1 Housing cover
- 2 DIP switch

Electrical connection

All connections required for operation are located on the back of the housing.

- ▷ Connect all necessary electrical connections to the product.
 - ⓘ If no connection or pulse cable has been ordered, the sensor is supplied with M12 connection plugs.
- ▷ Observe the country-specific regulations on electrical safety.

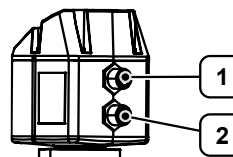

Figure 9: Connecting the product electrically (example)

- 1 Connector plug A
- 2 Connector plug B

Designation	Assignment	Plug
A Power supply	Pin 1 (VB+ (positive power supply)) Pin 2 (Modbus (A)) Pin 3 (VB- (negative power supply GND)) Pin 4 (Modbus (B)) Pin 5 (I+ (analog output))	



Designation	Assignment	Plug
B Direction / pulse	Pin 1 (Not Connected) Pin 2 (GND) Pin 3 (direction input) Pin 4 (Pulse / Alarm) Pin 5 (Pulse / Alarm)	
B M-Bus (optional)	Pin 1 (Not Connected) Pin 2 (GND) Pin 3 (direction input) Pin 4 (M-Bus) Pin 5 (M-Bus)	
B IO-Link (optional)	Pin 1 (VB+ (positive power supply)) Pin 2 (Not Connected) Pin 3 (VB- (negative power supply GND)) Pin 4 (C / Q) Pin 5 (Not Connected)	

Table 3: Pin assignment

Modbus-TCP Ethernet (optional)

- Connection cable: Cat 6

Designation	Plug type	Assignment	Plug
Modbus-TCP Ethernet Power over Ethernet (PoE)	M12 (x-coded)	Pin 1-2 (data line) Pin 3-4 (data line) Pin 5-6 (PoE cable) Pin 7-8 (PoE cable)	

Table 4: Pin assignment

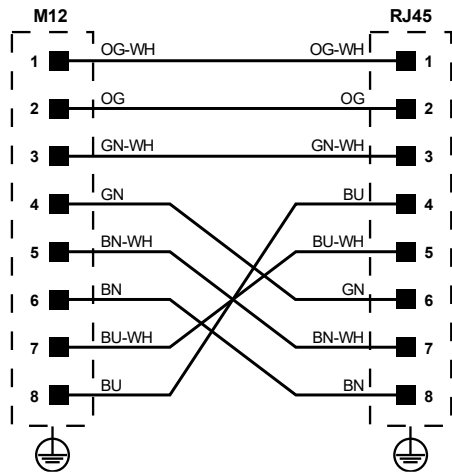

Figure 10: Wiring diagram Modbus-TCP Ethernet (T568B wiring standard)



HART (optional)

Prerequisite

- Optional HART interface available

The HART output is not electrically isolated, but must be operated via an electrically isolated power supply.

- ▷ Always connect the HART bus to the HART+ (24 V DC) and HART- (0 V) terminals in an electrically isolated manner.
- ▷ Do not use the sensor supply voltage for the HART bus, otherwise communication will not be possible.

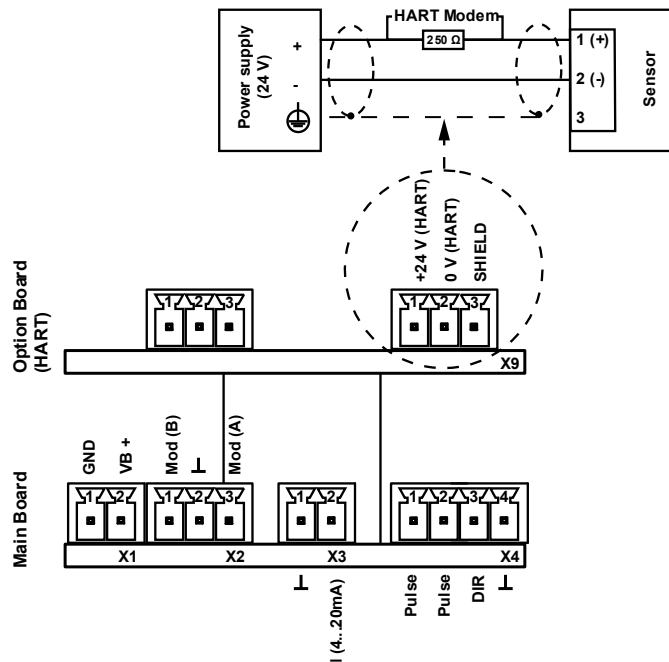

Figure 11: HART connection diagram

5.6 Initial commissioning



WARNING

Danger from pressurized components

Excessively low operating pressure over a long period of time increases the flow velocity in the pipe. There is a risk of injury from escaping pressure medium and impairment of the compressed air treatment system.

- ▷ Use a pressure maintenance system to ensure sufficient and stable operating pressure.
- ▷ Adjust the operating pressure to the consumer network during initial commissioning.

Putting the product into operation

- ▷ Connect the product to the power supply.
 - ✓ After connecting the power supply, the product performs a device initialization that lasts approximately 3 seconds.
 - ✓ The product measures the flow velocity in the middle of the pipe.



NOTE

To ensure the required measuring accuracy, a zero point adjustment is required at the start of each measurement.

Further information can be found in chapter "8.1.1 Carry out zero point adjustment".



5.7 Switching on and off

Switching on

- ▷ Connect the product to the power supply.
 - ✓ After connecting the power supply, the product performs a device initialization that takes about 3 seconds.
 - ⓘ The **main view** appears automatically after the device initialization is complete and serves as the starting point for all further operating procedures.

Switching off

- ▷ Disconnect the product from the power supply.
 - ✓ The device switches itself off.



6 Operation

6.1 Control elements

The user interface is operated using the two capacitive buttons.

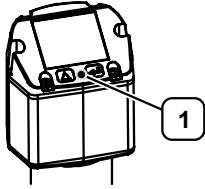

Figure 12: Control elements (example)

1 Capacitive buttons

Select menu items

- ▷ Select menu items with the Δ button.
- ▷ Confirm your selection with the \square ("OK") button.

Selecting digit positions

- ▷ Select a desired digit position with the Δ button .
- ▷ Activate the digit position with the \square button .
 - ⓘ Press the Δ button to increase the value at the active position by 1.
 - ⓘ Press the \square button to confirm the value at the active position.

6.2 User interface

The following user interface is displayed each time the product is started.

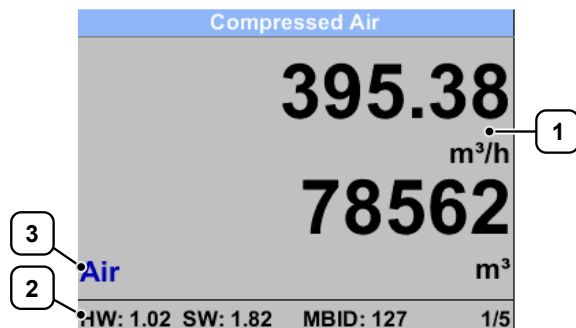

Figure 13: User interface | Main view (example)

1 Measured value
2 Status line

3 Gas type / status message

Status bar

Various information is displayed in the status bar:

- Hardware version
- Software version
- Modbus ID

7 Configuration

Open main menu

The main menu is the starting point for all central functions of the product.

**NOTE**

The main menu is password-protected.

Further information can be found in chapter "[7.1 Set up basic settings](#)".

- ▷ Tap the OK button.
- ▷ Enter the password.
 - ⓘ Password on delivery: **0000**
 - ✓ The main menu opens.

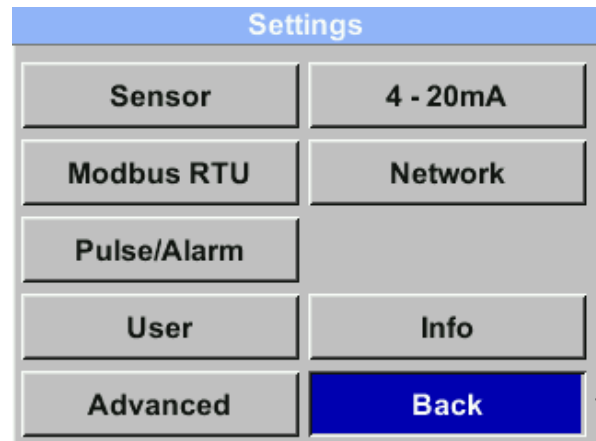

Figure 14: Open main menu (example)

7.1 Set up basic settings

Open user settings

- ▷ Select the User button.

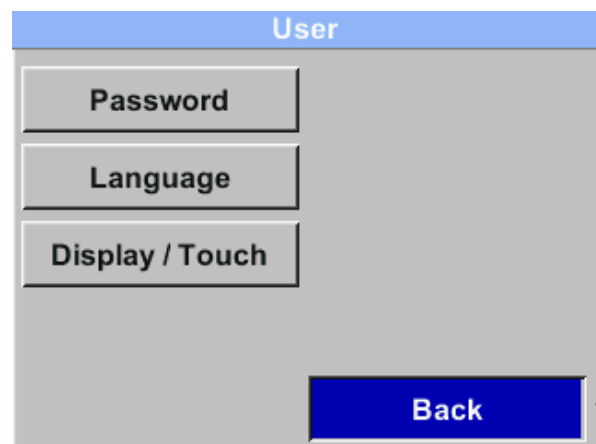

Figure 15: Open user settings (example)



Activate access protection

The main menu can be password-protected against unauthorized access.

- ▷ Select the Password button.
- ▷ Enter the desired password.
 - ⓘ The password must be a four-digit numeric code.
 - ⓘ Password on delivery: **0000**
- ▷ Repeat the entry for confirmation.
- ▷ Make a note of the password in a safe place.
 - ⓘ **If lost:** Contact customer service to reset the password.



Figure 16: Entering a new password (example)

Set language

German, English, Spanish and French are currently available as language settings.

- ▷ Select the Language button.
- ▷ Select the desired settings.

Set display

A reduced screen brightness value and a short screen switch-off time help to minimize energy consumption.

NOTICE
Burn-in of the display
 High, continuous display brightness can cause the display to burn in, among other things. Dimming the display helps to reduce this risk.

- ▷ Select the Display / Touch button.
 - ⓘ If the Rotate screen function is activated, the display is rotated by 180°.
 - ⓘ If the Key lock function is activated, operation is only possible after restarting and calling up the main menu within 10 seconds.
- ▷ Select the desired settings.

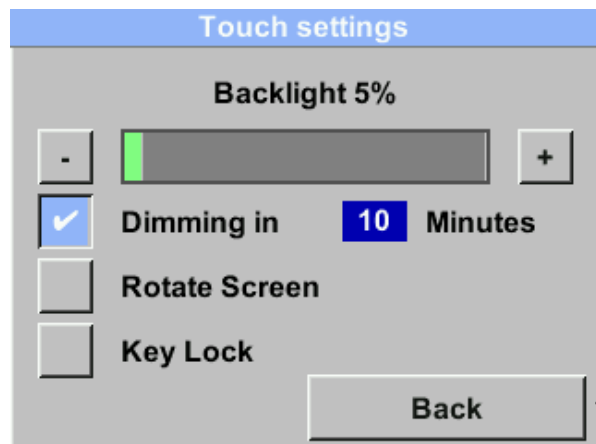

Figure 17: Setting the display (example)

7.2 Adjust configuration settings

CAUTION
Danger due to incorrect calibration
 Improper adjustment of the parameters can lead to considerable deviations in the measured values.

- ▷ Parameters may only be adjusted by qualified specialists with expert knowledge of the system and the monitored gases.

Open sensor settings

- ▷ Select the **Sensor** button.
- ✓ The menu for configuring the sensor settings opens.

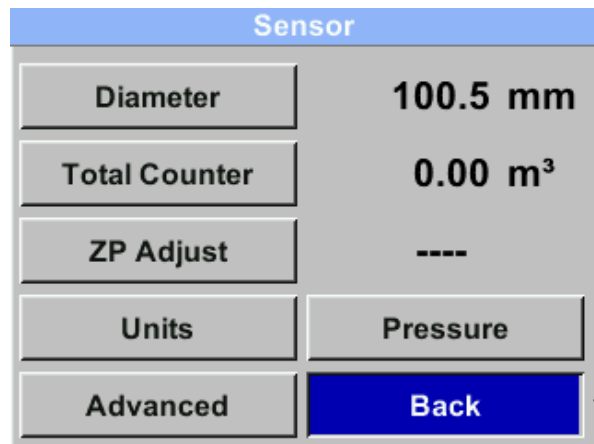
Figure 18: Set sensor parameters (example)
Adjusting the inner pipe diameter

The internal pipe diameter must be entered for correct measurement.

- ▷ Select the **Diameter** button.
- ▷ Select the desired settings.

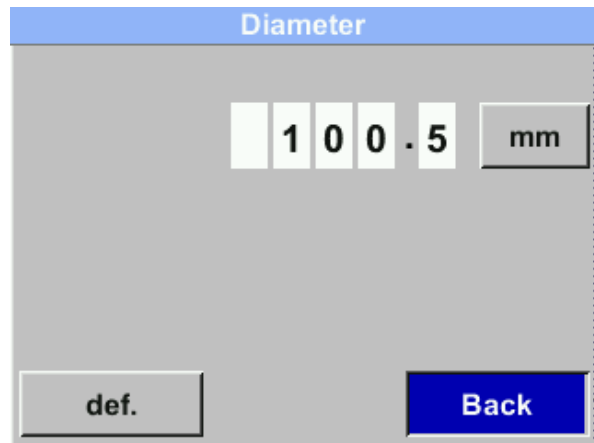
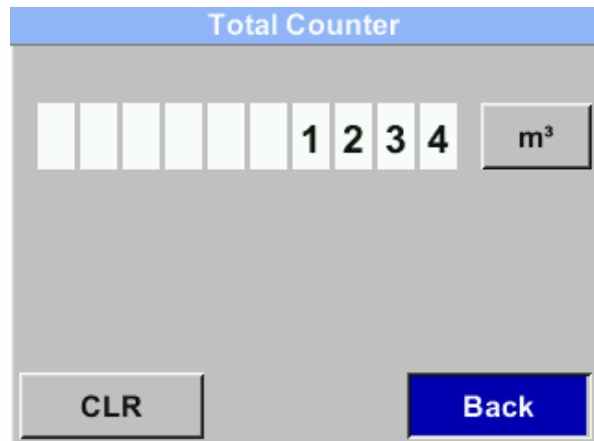

Figure 19: Adjust inner pipe diameter (example)

Parameters	Factory setting
Pipe inner diameter	53.1 mm

Table 5: Factory settings Inner tube diameter
Adjust consumption meter reading

The consumption meter reading can be adjusted and reset to zero manually if required.

- ▷ Select the **Consumption** button.
- ▷ Select the desired setting.
- ▷ Select the button with the currently displayed unit (e.g. m³) to set the desired unit.
 - ✓ The text on the button adapts to the selected unit.
- ▷ Select the **CLR** button to manually reset the consumption counter to zero.

Figure 20: Adjust consumption meter reading (example)



NOTE

When the maximum value (**1,000,000,000** [units]) is reached, the meter reading is automatically reset to zero.

Customize units

The system of units and measured variables can be adapted to country-specific specifications or individual requirements.

- ▷ Select the Units button.
- ▷ Select the desired settings.
 - ✓ The display units are adopted according to the selection and displayed correctly in all relevant areas.

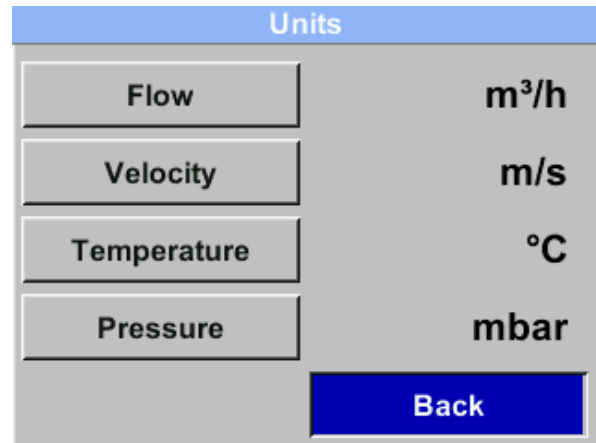

Figure 21: Customize units (example)

Adjusting reference conditions

To calculate the volume and consumption values correctly, the desired reference conditions for pressure and temperature must be defined.

- ▷ Select the Advanced > Reference standard command.
- ▷ Select the desired settings.
 - ⚠ Alternatively, 0 °C and 1013 hPa (= standard cubic meters) can be set as reference conditions.
 - ⚠ Operating pressure or operating temperature must **not be** entered as reference conditions.
- ▷ Select the Default button to restore the factory settings.

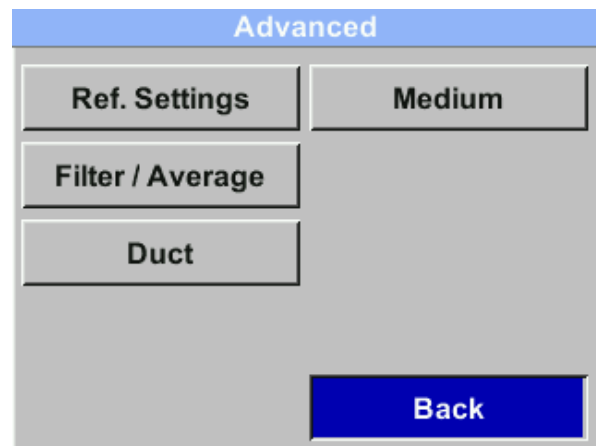

Figure 22: Adjusting reference conditions (example)



NOTE

In the Filter/Average menu item, both the attenuation of the measurement signal and the averaging period can be set.

It may be necessary to adjust the filter type for certain measurement applications:

- Normal: for general measurements
- Fast: for applications with very rapid changes in measured values
- Slow: for measurements after the compressor (pulsating flow)

7.3 Set interface parameters

Setting Modbus parameters (RTU)

For communication via the RS485 interface (Modbus RTU), the communication parameters must be adjusted before commissioning.

- ▷ Select the **Modbus RTU** button.
- ▷ Select the desired settings.
- ▷ Select the **Default** button to restore the factory settings.

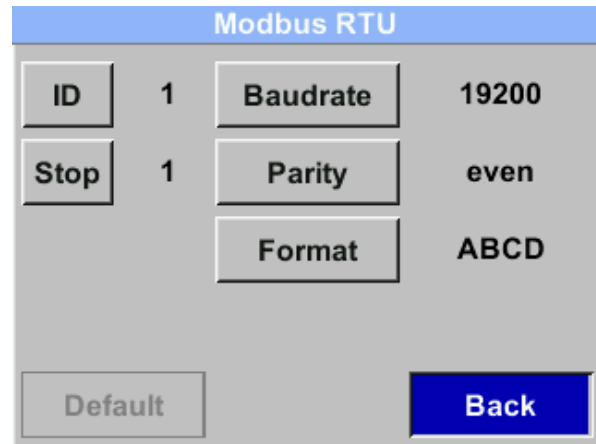

Figure 23: Setting Modbus parameters (example)

Parameters	Factory setting
ID	1
Baud rate	19200
Stop bit	1
Parity	even
Data format	ABCD (Big Endian)

Table 6: Modbus factory settings

Set Modbus TCP parameters (optional)

Prerequisite

- Optional Modbus TCP interface available

The optional Modbus TCP interface enables communication via the Modbus TCP protocol. The Modbus device address (unit identifier) can be selected in the range 1-247.

- ▷ Select the **Network** button.
- ▷ Select the **IP address** button to establish a connection to a computer.
 - ⓘ DHCP activated: automatic integration into existing network without the need for manual configuration.
 - ⓘ DHCP deactivated: manual integration into existing network (assignment of a static IP address).
- ▷ Select the desired settings.
- ▷ Select the **Modbus TCP** button to set the Modbus TCP parameters.
- ▷ Select the desired settings.
- ▷ Select the **Default** button to restore the factory settings.

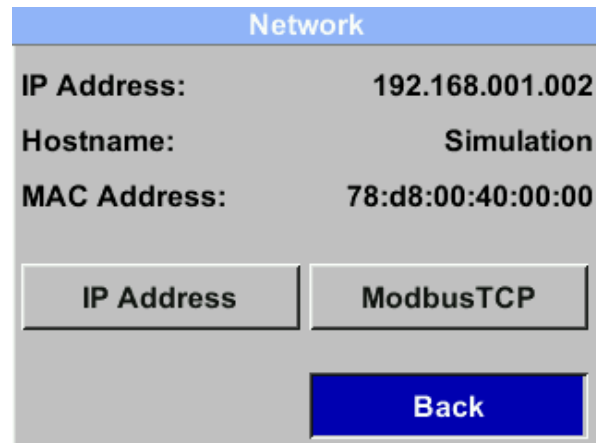

Figure 24: Setting Modbus TCP parameters (example)

Function code	Description
03	Read holding register
16	Write multiple registers

Table 7: Supported Modbus function codes



Parameters	Factory setting
ID	1
port	502
Data format	ABCD (Big Endian)
Timeout	10 s

Table 8: Factory settings Modbus TCP

Set M-Bus parameters (optional)

Prerequisite

- Optional M-Bus interface available

The optional M-Bus interface enables communication with consumption meters and control systems via the M-Bus protocol. The M-Bus address can be selected in the range 1-250. Both the primary address and the secondary address (ID) can be searched for automatically in the M-Bus system.

NOTICE

Value Information Field (VIF)

The product supports the following VIF encodings:

- ▷ **Primary VIF** (factory setting): Encoding is performed in accordance with the M-Bus specification. The unit and multiplier are stored separately in standardized codes. The values and units are permanently configured and **cannot** be changed.
For further information, see "[Table 10: Factory settings for transmitted values](#)".
- ▷ **Plain Text VIF**: Measured values, units, and scaling (if applicable) are transmitted together as an ASCII character string. The values can be configured at the factory or on site using the service software.

- ▷ Select the **M-Bus** button.
- ▷ Select the **Address** button to set the primary M-Bus address.
 - ⓘ The secondary M-Bus address (ID) is fixed and cannot be changed.
- ▷ Select the desired settings.
- ▷ Select the **Baud rate** button to set the baud rate.
 - ⓘ The baud rate can be selected with the values 2400, 4800 or 9600.
- ▷ Select the desired settings.
- ▷ Select the desired VIF encoding.
 - ⓘ Primary VIF: Units as string deactivated (factory setting).
 - ⓘ Plain Text VIF: Activate the **Units as string** option.

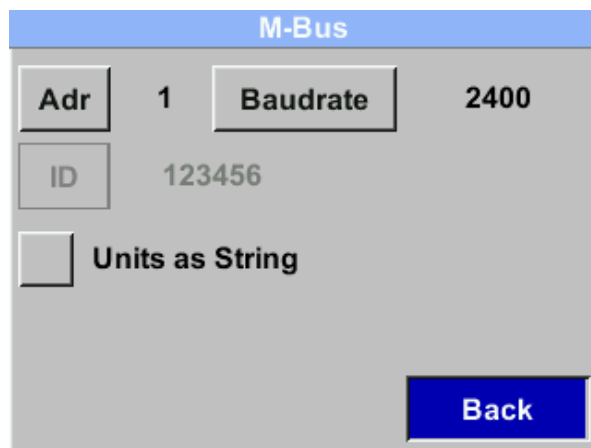

Figure 25: Setting M-Bus parameters (example)

Parameters	Factory setting
Primary M-Bus address	1
Baud rate	2400
ID	Serial number
Medium	Depending on application (gas or compressed air)
Manufacturer identification	CSI
VIF coding	Primary VIF

Table 9: Factory settings Communication parameters

Value	Designation	Unit
1	Consumption	m



Value	Designation	Unit
2	Flow rate	m³/h
3	Gas temperature	°C
4	System pressure	bar

Table 10: Factory settings for transmitted values

Set IO-Link parameters (optional)

Prerequisite

- Optional IO-Link interface available

The IO-Link option enables digital communication between the device and the control system. Device parameters can be read out, set and diagnostic information transmitted.

Required for configuration:

- IO-Link-capable master port
- Suitable IODD file (IO Device Description)

Basics for the configuration:

- Standard sensor cable, 3-wire, max. 20 m (according to specification)
- Supported mode: SDCI
- Connection to IO-Link master port required
- Integration via IODD file
- Parameterization and diagnostics possible via IO-Link engineering tools or control system

Designation	Value
Transmission type	COM 2 (38.4 kBaud)
Specification	V1.1
SDCI standard	IEC 61131-9 CDV
Device ID	1005 - 1008 / 0x3ED - 0x3F0 (depending on upper range value)
Profile	Identification and Diagnosis (0x4000)
SIO mode	No
Required master port class	A
Process data analog	4
Process data binary	---
Min. process cycle time	20.4 ms

Table 11: Interface parameters (IO-Link)

Setting HART parameters (optional)

Prerequisite

- Optional HART interface available

The optional HART interface enables the transmission of defined process values.

Variable	Unit	Class	Description
0	m³/h	Volumetric Flow	Flow value as shown in the display
1	m³	Volume	Totalizer (integer portion) as shown in the display
2	°C	Temperature	Gas temperature as shown on the display
3 ¹	mbar	Pressure ²	System pressure (in the unit set on the display)

Table 12: Transmitted values (HART)

¹ Only available in conjunction with the "Pressure" option.

² Optional; NaN = no valid measured value (e.g. if the pressure sensor option is missing)



7.4 Set output parameters

Configuring an electrically isolated output

The galvanically isolated output can be defined as a pulse or alarm output.

- ▷ Select the Pulse/Alarm > Relay function command to set the output type.
- ▷ Select the desired settings.

Pulse/Alarm	
Relay Mode	Pulse
Unit	m ³
Value	0.10
Polarity	pos.
Pulse/s at Max. Flow	0.278
	Back

Figure 26: Configure galvanically isolated output (example)

Parameter	Description
Unit	Defines unit
Value	Defines alarm value or pulse value ¹
Hysteresis	Defines desired hysteresis <ul style="list-style-type: none"> • Exceeding: Alarm when value is exceeded • Fall below: Alarm when value falls below
Polarity	Defines the switching status <ul style="list-style-type: none"> • positive = 0 --> 1 (output: closed --> open) • negative = 1 --> 0 (output: open --> closed)

Table 13: Parameters for output configuration

Pulse output

A maximum of 50 pulses per second can be output. The pulses are output with a delay of 1 second.

Pulse value	m ³ /h	m ³ /min	l/min
0.1 l/pulse	18	0,3	300
1 l/pulse	180	3	3000
0.1 m ³ /pulse	18 000	300	300 000
1 m ³ /pulse	180 000	3 000	3 000 000

Table 14: Maximum flow rates for pulse output

NOTE
Inputs of pulse values that do not allow a display for the upper range value are not permitted. In this case, the input is rejected and an error message is displayed.

¹ The lowest pulse value is based on maximum consumption and 50 Hz pulse frequency.

Configuring the analog output

The measuring range of the analog output (4-20 mA) can be freely configured.

- ▷ Select the **4 - 20 mA** button.
- ▷ Select the **Channel 1** button to configure the measured value and scaling.
 - ❗ A measured value (temperature, speed, or flow) can be assigned to each channel.
 - ❗ Scaling can be performed automatically (Auto Scaling = on) or manually (Auto Scaling = off). With automatic scaling, this is calculated based on the pipe diameter, the maximum valid measuring range of the product, and the reference conditions.
- ▷ Select the desired settings.
- ▷ Select the **Error Current** button to specify which value is output at the analog output in the event of an error.
- ▷ Select the desired settings.

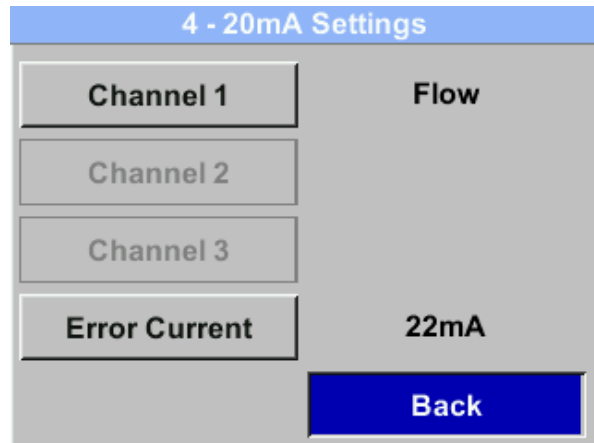

Figure 27: Configuring the analog output (example)

Setting	Meaning
2 mA	Sensor error / System error
22 mA	Sensor error / system error
None	Output according to NAMUR (3.8 mA - 20.5 mA) <ul style="list-style-type: none"> • < 4 mA - 3.8 mA = measurement range undershoot • > 20 mA - 20.5 mA = measurement range exceeded

Table 15: Output values for error current

Output	Factory setting
Channel 1	0... Maximum flow rate [m ³ /h] (For maximum flow rate, see chapter "11.1 Technical data")
Channel 2 ¹	-20...+100 °C

Table 16: Factory settings for analog output

¹ Only available in conjunction with the "analog output board" option.



8 Consumption measurement

8.1 Adjust measurement parameters

**CAUTION****Danger due to incorrect calibration**

Improper adjustment of the parameters can lead to considerable deviations in the measured values.

- ▷ Parameters may only be adjusted by qualified specialists with expert knowledge of the system and the monitored gases.

Open sensor settings

- ▷ Select the **Sensor** button.
 - ✓ The menu for configuring the sensor settings opens.

Sensor	
Diameter	100.5 mm
Total Counter	0.00 m ³
ZP Adjust	----
Units	Pressure
Advanced	Back

Figure 28: Set sensor parameters (example)

8.1.1 Carry out zero point adjustment

**NOTICE****Ensuring measurement accuracy**

To ensure the required measuring accuracy, a zero point adjustment is required at the start of each measurement.

- ▷ Carry out a zero point adjustment regularly, at least every 180 days, to ensure precise measurement results.

Preparing the zero point adjustment

A zero point adjustment only provides reliable measurement results under stable conditions. It must be carried out with the system pressure applied and without flow.

**NOTICE****Mechanical preparation**

Before zero point adjustment, the sensor must be mechanically released and pulled out as far as it will go.

- ▷ Loosen the clamping sleeve.
- ▷ Pull the sensor out completely as far as it will go.
- ▷ Make sure that there is no flow.
- ▷ Align the sensor parallel to the pipe using the positioning wrench supplied.
- ▷ After correct alignment, wait 20 seconds until you carry out the zero point adjustment on the software side.

- ▷ Ensure that there is no flow in the pipe.
 - ⓘ To do this, apply system pressure to the product.
- ▷ Then start the zero point adjustment via the user interface on the sensor.



Perform zero point adjustment



NOTE

If the sensor displays a flow value greater than 0 m³/h without flow, the zero point of the characteristic curve can be set at this point.

- ▷ Select the command **Zero point** > **Zero point**.
- ▷ Follow the steps displayed to adjust the zero point.
 - ✓ After successful zero point adjustment, the differential pressure value **DeltaPressure** is displayed on the user interface with **0.00 hPa**.
 - ⓘ The sensor can be reset to the factory setting using the **Reset** button.

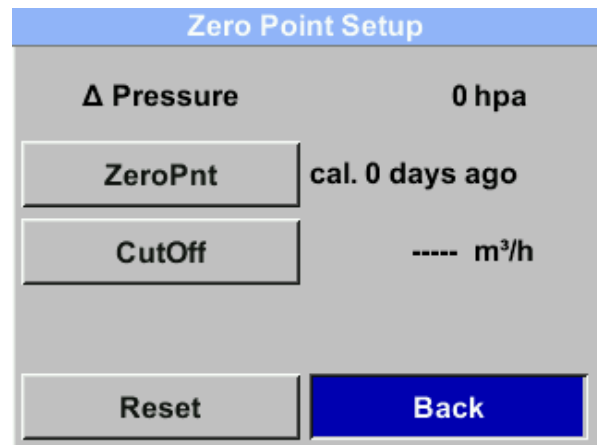

Figure 29: Performing zero point adjustment (example)

Complete the zero point adjustment



NOTE

The sensor tip must not be twisted or moved after the zero point adjustment, as even slight changes in position can falsify the measurement results.

- ▷ After zero point adjustment, fit the sensor tip back into the pipe without changing the alignment.
 - ⓘ Further information can be found in chapter "[5.3 Assemble product](#)".

8.1.2 Adjust creep suppression

Adjusting creeping flow suppression

Creeping flow suppression ensures that flow values below the defined "low flow cut-off" value are displayed as 0 m³/h and are not included in the consumption meter. In this way, very low flow values that can no longer be reliably measured are suppressed.

- ▷ Select the command **Zero point** > **Creeping quantities**.
- ▷ Select the desired setting.

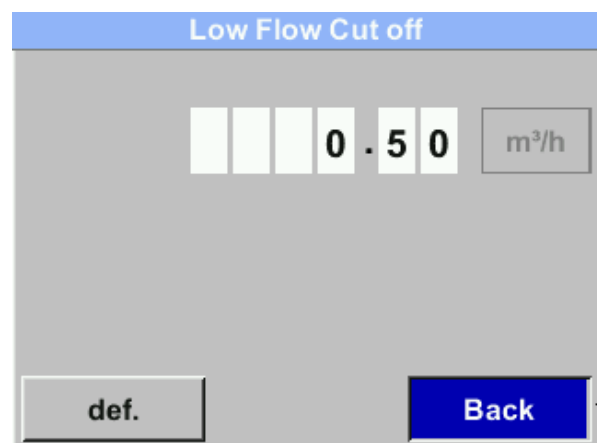

Figure 30: Adjust creeping flow suppression (example)



8.2 Carry out consumption measurement

Query measurement data

Several views are available on the home screen to display the measured values.

▷ Select the ▷ button to switch to the next view.

Average Min. Max.			
Flow: m ³ /h	AV	Min	Max
395.38			0
207.45			870.87
Total Counter: m ³			
78562			
82.7			
AV-Time:	1440 Minutes		3/5

Figure 31: Average value view (example)

9 Maintenance and servicing



CAUTION

Safety instructions

- ▷ The product may only be serviced by a qualified electrician.
- ▷ Work on the electrical equipment of the product may only be carried out by qualified electricians or by instructed persons under the direction and supervision of a qualified electrician in accordance with the electrotechnical regulations.
- ▷ Spare parts must comply with the technical requirements specified by the manufacturer (CS INSTRUMENTS). This is always guaranteed with original spare parts.



NOTICE

Measuring errors due to dirt particles in the compressed air

Dirt particles and fluids can contaminate the product and lead to a malfunction or fault.

- ▷ The system operator must ensure the prescribed purity of the fluids approved for the application as well as appropriate cleaning and maintenance intervals.
- ▷ The manufacturer (CS INSTRUMENTS) accepts no warranty or liability for incorrect use.



NOTE

Unless expressly described otherwise, only begin maintenance and servicing work after

- the product has been disconnected from the power supply,
- the product has been switched off and secured against being switched on again.

9.1 Clean product

Cleaning the housing

If the housing is dirty, clean it with solvent-free cleaning agents.

- ▷ Use a slightly damp, lint-free cloth to clean the housing regularly.
- ▷ Check the product for damage and corrosion.

Cleaning the screen

If the screen is dirty, clean it with solvent-free cleaning agents.

- ▷ Use a slightly damp, lint-free cloth to clean the screen regularly.

9.2 Check cables



DANGER

Danger to life due to electrical voltage

During installation, maintenance or in the event of a fault, touchable conductive parts can carry dangerous voltages. Contact with uninsulated parts or mains voltage can lead to serious injury or death.

- ▷ Do not operate the product if power supply cables are damaged or housing parts are defective or removed.
- ▷ Strictly observe all locally applicable regulations and safety regulations.
- ▷ Only carry out work on electrical connections when the power supply is switched off. Secure the product against unintentional restarting.
- ▷ Check all electrical connections before commissioning and regularly during operation.

**CAUTION****Danger from commissioning a damaged product**

If a damaged product is installed or put into operation, it may result in functional failures, electrical hazards, or mechanical risks.

- ▷ Before each start-up, inspect the product, accessories, and all supply lines for visible damage, loose parts, or missing components.
- ▷ Immediately take any defective product out of operation immediately.

Check cables**Prerequisite**

- The product is de-energized and freely accessible.

The electrical cables of the product must be checked regularly by a qualified person.

The user is responsible for determining suitable maintenance intervals.

- ▷ Check the electrical cables for damage.

9.3 Check mechanical components and connections

Check mechanical components and connections

The mechanical and electrical connections of the system must be checked for tightness, integrity and leak tightness.

The user is always responsible for determining suitable maintenance intervals.

Prerequisite

- The product is de-energized and freely accessible.
- ▷ Check all pipe connections, hoses and screw connections for tightness and visible leaks.
- ▷ Carefully tighten any loose connections.
- ▷ Check for wear, cracks or leaks.
- ▷ Check the clamping points of the electrical installation for firm contact and freedom from corrosion.
- ▷ Carry out a leak test of the entire system.

9.4 Perform calibration

Observe calibration intervals

The user is responsible for determining suitable intervals.

Increased maintenance work is to be expected under the following conditions in particular:

- Extreme temperatures (especially low temperatures)
- Damp compressed air
- Falling or overloading of the product
- Interventions for repair purposes
- ▷ Observe the specifications in the quality management manual (QM system).
 - ⓘ The calibration interval must be defined dynamically - preferably using a procedure anchored in the QM system. Without corresponding specifications, the determination is risk-based and based on economic considerations.
 - Frequent recalibration: higher operating costs
 - Rare recalibration: risk of invalid measurement results
- ▷ Always have the product calibrated after special operating conditions.

Have a factory calibration performed

- ▷ Send the product to the manufacturer (CS INSTRUMENTS).
 - ⓘ An identical replacement product should be kept in stock for use in critical systems.
- ▷ Select the **Info** button to display the calibration conditions.

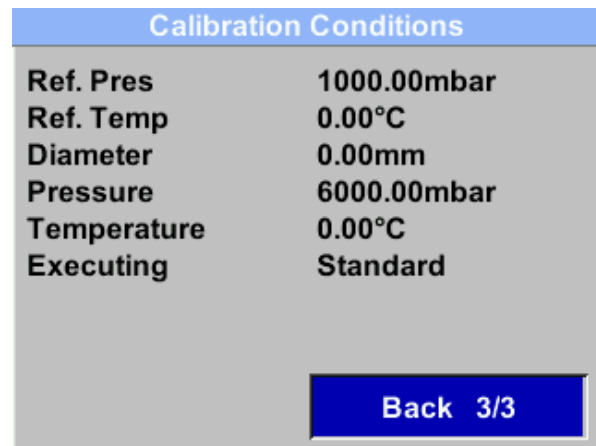

Figure 32: Display calibration conditions (example)

9.5 Update software

9.5.1 Download software package

- ▷ Visit the manufacturer's homepage at (CS INSTRUMENTS).
- ▷ Download the appropriate software package.
 - ⓘ The current hardware and software versions along with the serial number are displayed under the **About** tab.
- ▷ Save the software package in the desired target directory or on the desired USB storage device.

9.5.2 Establish connection

- ▷ Connect the service/diagnostic interface (RS485) of the product to your computer.
 - ⓘ Further information can be found in chapter "[5.5 Connect product](#)".

NOTICE
Avoiding inconsistent data

The product is locked during an active connection with the computer. This prevents changes to the product and protects against inconsistent or incomplete data transfers.

- ▷ Do not disconnect manually during data transfer.

9.5.3 Performing a software update

The software update is carried out via the service software.

- ▷ Contact customer service to carry out the software update.

9.6 Error states

9.6.1 Correct error states

Correcting error states

Warnings continue to allow measurement without affecting the measured value. Measurement is not possible in the event of errors.

- ▷ Contact customer service if necessary.

Message	Message Description	Remedy
Low voltage	Supply voltage < 18 V. Sensor cannot measure properly. No measured values are available for flow rate, consumption and speed.	<ul style="list-style-type: none"> ▷ Check the supply voltage. ▷ Ensure that it is within the range of 18... 36 V DC.



Message	Message Description	Remedy
Internal error	Internal read error, e.g. on the EEPROM or AD converter.	<ul style="list-style-type: none"> ▷ Restart the sensor. ▷ If the error persists, contact customer service.
Temp out of range	Media temperatures outside the specified temperature range. Media temperatures outside the specified temperature range result in measured values outside the sensor limits.	<ul style="list-style-type: none"> ▷ Check the media temperature. ▷ Ensure that it is within the specified temperature range.
Low voltage 4-20 mA	Supply voltage < 17.5 V. A minimum supply voltage of 17.5 V is required for sensors with galvanically isolated 4-20 mA output.	<ul style="list-style-type: none"> ▷ Check the wiring of the 4-20 mA output.
CalZeroPnt	Zero point adjustment must be carried out.	<ul style="list-style-type: none"> ▷ Carry out the zero point adjustment. ④ Further information can be found in chapter "8.1.1 Carry out zero point adjustment".
Not calibrated	Error message is issued if an incorrect gas is selected in the sensor settings. The sensor is calibrated for the specific application.	<ul style="list-style-type: none"> ▷ Check the gas selection in the settings. ▷ Select the gas calibrated for the sensor.
Pressure Error	Error message if the signal is incorrect or the internal pressure sensor is defective.	<ul style="list-style-type: none"> ▷ Check the function of the sensor. ▷ If the error persists, contact customer service.
DeltaPressure Error	Error message if the signal is faulty or the internal differential pressure sensor is defective.	<ul style="list-style-type: none"> ▷ Check the function of the sensor. ▷ If the error persists, contact customer service.
dP Range	Selected measuring range exceeded.	<ul style="list-style-type: none"> ▷ Check the selected measuring range and adjust it if necessary.
Next cal. elapsed	Period for next calibration exceeded.	<ul style="list-style-type: none"> ▷ Carry out a calibration of the sensor.

Table 17: Error and status messages

9.6.2 Restore factory settings

Restoring the factory settings

If necessary, the product can be reset to the factory settings to restore the delivery status.

- ▷ Select the **Advanced** > **Factory reset** command.

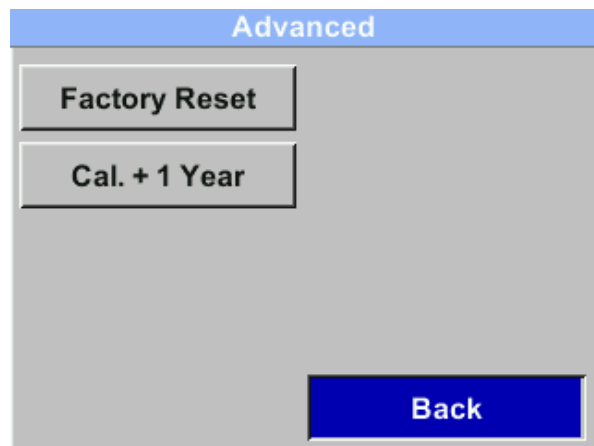

Figure 33: Restore factory settings (example)



9.7 Customer service

For rapid processing by customer service

Prerequisite

- Material number (product rating plate)
- Serial number (product rating plate)
- ▷ Describe the problem as precisely as possible.
- ▷ Make a note of any error messages displayed.
- ▷ Inform customer service about:
 - When does the problem occur?
 - How often does it occur?
 - What changes were last made to the product, the configuration, or the environment?



10 Decommissioning and disposal

Decommissioning

Decommissioning is defined as an extended period of non-use of the components. The components must then be protected from external influences.

- ▷ If necessary, disconnect the components from the power supply.
- ▷ Properly package the components if they will not be used for an extended period.
- ▷ Store the components in a manner that prevents exposure to significant temperature fluctuations. Resulting condensation can lead to moisture buildup and cause corrosion.

Disposal

Parts and components that have reached the end of their service life, e.g. due to wear, corrosion and mechanical stress, must be properly disposed of after disassembly, in accordance with national regulations.

The product and packaging contain recyclable materials that must not be disposed of with residual waste.

- ▷ Separate the components after recycling.
 - ⓘ Disposal code according to the European Waste Catalog (EWC) 16 02 14, electrical and electronic devices and their components.
- ▷ Dispose of the components in an environmentally responsible manner, in accordance with local regulations or through a certified disposal company.



NOTE

Information on environmentally responsible disposal can be obtained from local authorities, or certified disposal companies.

- ▷ Alternatively, you can return the product to the manufacturer (CS INSTRUMENTS) at the end of its service life.

11 Appendix

11.1 Technical data

Parameters	Specification	Unit
Weight	~ 1,5	kg
Power supply	18... 36 via SELV 5 W Standard version: PoE according to IEEE 802.3af, class 2 (3.84...6.49 W)	V DC
Fuse protection	T2.5L, 2.5 A / 125 V, slow-blow (device protection through integrated fuse against overcurrent)	
Power consumption	Max. 5	W
Electrical connection	Via cable entry to internal connections	
Measuring range	High speed version: max. 224 [flow velocity (compressed air ¹)]	m/s
	Ultra High Speed version: max. 600 [flow velocity (compressed air)] m/s	m/s
	Gases version: 0.04...500 [differential pressure (gases)]	mbar
Measuring principle	Differential pressure	
Measuring span	1:100 (1...300)	
Response time	(t99): < 1 s	
Measuring accuracy	±1.5% of measured value	
Repeatability	0.25% of measured value (when installed correctly)	
Accuracy specifications	Based on: <ul style="list-style-type: none"> Ambient temperature: 22 °C ±2 °C System pressure: 6 bar 	
Measured variables	<ul style="list-style-type: none"> Flow Total consumption Pressure Temperature Speed 	
Operating pressure	-1...+30 (operating pressures > 10 bar: additional high pressure protection required)	bar
Mounting thread	Depending on version: <ul style="list-style-type: none"> G ½" NPT ½" PT ½" 	
Display	Optional: <ul style="list-style-type: none"> TFT color display Size: 1.8" Resolution: 220 x 176 pixels 	
Digital output	<ul style="list-style-type: none"> RS485 (Modbus-RTU), according to EIA/TIA-485 standard Modbus-TCP Ethernet (optional) M-Bus (optional) IO-Link (optional) 	
Analog output	1 x 4...20 mA active (not galvanically isolated), R _L < 500 Ω	
Pulse output	Galvanically isolated; potential-free switching contact; max. 48 V DC, 150 mA; max. 50 Hz	
Alarm output	Galvanically isolated; max. 48 V DC, 150 mA; NC (normally closed)	
Area of application	Indoor and outdoor use	
Degree of soiling	2	

¹ related to ISO 1217 at 1000 mbar and 20 °C



Parameters	Specification	Unit
Ambient temperature	-20...+70	°C
Storage temperature	-40...+80	°C
Air humidity	Max. 90% relative humidity, non-condensing	
Altitude clearance	Up to 4000 m above sea level (Use above 2000 m only with correspondingly approved power supply)	
Protection class	IP65	

Table 18: Technical data VD 500

Parameters	Specification	Unit
Measuring medium	Compressed air (at least ISO 8573-1 (particle-moisture-oil) class 5-6-4)	
Materials in contact with the medium	Stainless steel 1.4404	
Media temperature	-30 ...+180	°C
Media humidity	max. 99.9% relative humidity, non-condensing	

Table 19: Technical data | Measuring medium

11.2 Dimensions

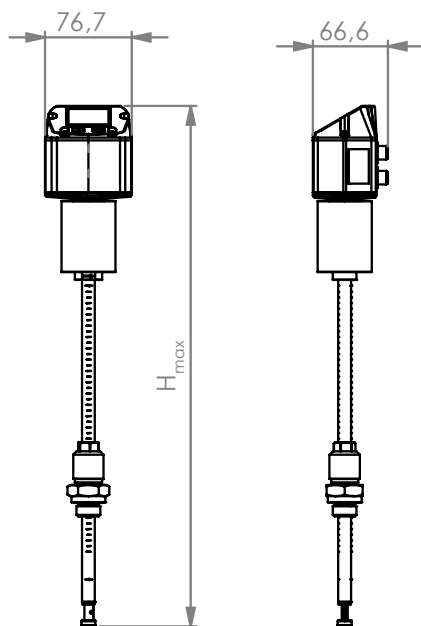

Figure 34: Dimensions

Shank length	H_{max}	Unit
220	460,5	mm
400	635,5	mm

Table 20: Maximum height (H_{max}) depending on the shaft length

11.3 Measuring ranges

Measuring tube (inner diameter)		Volume flow $v_{max} = 224$ m/s		Volume flow $v_{max} = 600$ m/s	
[inch]	[mm]	[Nm ³ /h] ¹	[Nm ³ /h] ²	[Nm ³ /h]*	[Nm ³ /h]**
3/4"	21,7	215	198	578	531

¹ ** Reference conditions: according to ISO 1217 (20 °C, 1000 mbar), medium: compressed air

² **** Reference conditions: in accordance with ISO 2533 (0 °C, 1013.25 mbar), medium: compressed air



Measuring tube (inner diameter)		Volume flow $v_{\max} = 224 \text{ m/s}$		Volume flow $v_{\max} = 600 \text{ m/s}$	
[inch]	[mm]	[Nm ³ /h] ¹	[Nm ³ /h] ²	[Nm ³ /h]*	[Nm ³ /h]**
1"	25,0	295	272	791	727
	26,0	321	296	860	791
	27,3	357	328	956	879
	28,5	391	360	1048	964
	30,0	437	402	1171	1077
1 1/4"	32,8	529	487	1416	1302
	36,0	644	592	1724	1585
	36,3	655	603	1755	1614
1 1/2"	39,3	775	713	2075	1908
	40,0	804	740	2152	1979
	41,9	886	816	2374	2183
	43,1	941	866	2521	2318
	45,8	1068	983	2861	2631
2"	50,0	1283	1180	3435	3158
	51,2	1346	1239	3607	3316
	53,1	1450	1335	3884	3571
	54,5	1529	1408	4097	3767
	57,5	1713	1577	4588	4218
	60,0	1870	1721	5008	4605
	64,2	2148	1977	5755	5291
2 1/2"	65,0	2205	2029	5906	5430
	70,3	2589	2383	6934	6376
	71,1	2648	2437	7092	6521
	76,1	3041	2799	8145	7489
3"	80,0	3364	3097	9012	8286
	82,5	3582	3297	9595	8822
	84,9	3794	3492	10162	9344
	90,0	4268	3929	11433	10512
4"	100,0	5276	4856	14132	12994
	107,1	6059	5577	16229	14922
	110,0	6391	5883	17120	15741
5"	125,0	8263	7606	22134	20351
	133,7	9453	8701	25321	23282
6"	150,0	11913	10965	31910	29340
	159,3	13436	12367	35990	33091
	182,5	17656	16251	47293	43484
	190,0	19137	17614	51260	47131
8"	200,0	21230	19540	56865	52285
	206,5	22632	20831	60621	55738
10"	250,0	33211	30568	88958	81793
	260,4	36075	33204	96628	88845
12"	300,0	47881	44070	128252	117922
	309,7	51027	46966	136680	125690
	339,6	61356	56473	164345	115130
	400,0	85122	78347	228004	209670



Measuring tube (inner diameter)		Volume flow $v_{\max} = 224 \text{ m/s}$		Volume flow $v_{\max} = 600 \text{ m/s}$	
[inch]	[mm]	[Nm ³ /h] ¹	[Nm ³ /h] ²	[Nm ³ /h]*	[Nm ³ /h]**
	500,0	133003	122417	356256	327610
	600,0	191524	176281	513009	471758
	700,0	260685	239938	698262	642116
	800,0	340487	313388	912017	838682
	900,0	430929	396632	1154271	1061458
	1000,0	532011	489669	1425026	1310441

Table 21: Measuring range end values

11.4 Register assignment

Register	Address	Number of bytes	Data type	Description	Standard	Access	Unit/ Comment
2001	2000	2	uint16	Modbus ID	1	Read-Write	Modbus ID 1...247
2002	2001	2	uint16	Baud rate	4	Read-Write	0 = 1200 1 = 2400 2 = 4800 3 = 9600 4 = 19200 5 = 38400 6 = 57600 7 = 115200
2003	2002	2	uint16	Parity	1	Read-Write	0 = none 1 = even 2 = odd
2004	2003	2	uint16	Number of stop bits		Read-Write	0 = 1 stop bit 1 = 2 stop Bit
2005	2004	2	uint16	Word Order	0xABCD	Read-Write	0xABCD = Big Endian 0xCDAB = Middle Endian
2069	2068	4	float	Pressure Type (Relative / Absolute)		Read-Write	0 = Relative 1 = Absolute

Table 22: Modbus settings (registers 2001-2005)

Register	Address	Number of bytes	Data type	Description	Standard	Access	Unit/ Comment
1101	1100	4	float	Flow in m ³ /h		Read-Only	
1109	1108	4	float	Flow in Nm ³ /h		Read-Only	
1117	1116	4	float	Flow in m ³ /min		Read-Only	
1125	1124	4	float	Flow in Nm ³ /min		Read-Only	
1133	1132	4	float	Flow in ltr/h		Read-Only	
1141	1140	4	float	Flow in Nltr/h		Read-Only	
1149	1148	4	float	Flow in ltr/min		Read-Only	
1157	1156	4	float	Flow in Nltr/min		Read-Only	
1165	1164	4	float	Flow in ltr/s		Read-Only	



Register	Address	Number of bytes	Data type	Description	Standard	Access	Unit/ Comment
1173	1172	4	float	Flow in Nltr/s		Read-Only	
1181	1180	4	float	Flow in cfm		Read-Only	
1189	1188	4	float	Flow in Ncfm		Read-Only	
1197	1196	4	float	Flow in kg/h		Read-Only	
1205	1204	4	float	Flow in kg/min		Read-Only	
1213	1212	4	float	Flow in kg/s		Read-Only	
1221	1220	4	float	Flow in kW		Read-Only	
1269	1268	4	uInt32	Consumption m ³ before comma	x	Read-Only	
1275	1274	4	uInt32	Consumption Nm ³ before comma	x	Read-Only	
1281	1280	4	uInt32	Consumption ltr before comma	x	Read-Only	
1287	1286	4	uInt32	Consumption Nltr before comma	x	Read-Only	
1293	1292	4	uInt32	Consumption cf before comma	x	Read-Only	
1299	1298	4	uInt32	Consumption Ncf before comma	x	Read-Only	
1305	1304	4	uInt32	Consumption kg before comma	x	Read-Only	
1311	1310	4	uInt32	Consumption kWh before comma	x	Read-Only	
1347	1346	4	float	Velocity m/s			
1355	1354	4	float	Velocity Nm/s			
1363	1362	4	float	Velocity Ft/min			
1371	1370	4	float	Velocity NFt/min			
1419	1418	4	float	GasTemp °C			
1427	1426	4	float	GasTemp °F			
1475	1474	4	float	System pressure mBar	x	Read-Only	Value depending on register "Pressure type" setting
1481	1480	4	float	System pressure Bar		Read-Only	
1487	1486	4	float	System pressure PSIr		Read-Only	
1057	1056	4	float	Delta P		Read-Only	Unit as defined in sensor

Table 23: Value register (register 1001-1500)



11.5 Declaration of conformity



KONFORMITÄTSERKLÄRUNG

DECLARATION OF CONFORMITY

Wir CS Instruments GmbH & Co.KG
We Zindelsteiner Straße 15, 78052 Villingen-Schwenningen

Erklären in alleiniger Verantwortung, dass die Produkte
Declare under our sole responsibility that the products

Verbrauchs-/ Durchflusssensor VD 500, VD520
Flow Sensor VD 500 , VD 520

den Anforderungen folgender Richtlinien entsprechen:
We hereby declare that above mentioned components comply with requirements of the following EU directives:

Elektromagnetische Verträglichkeit Electromagnetic compatibility	2014/30/EU 2014/30/EC
RoHS (Restriction of certain Hazardous Substances)	2011/65/EC & 2015/863/EC

Angewandte harmonisierte Normen:

Harmonised standards applied:

EMV-Anforderungen EMC requirements	EN 55011:2016 + A2:2021-04 EN 61326-1: 2013-07
RoHS (Restriction of certain Hazardous Substances)	EN IEC 63000:2018

Das Produkt ist mit dem abgebildeten Zeichen gekennzeichnet.
The product is labelled with the indicated mark.



Harrisee, den 14.01.2026

Wolfgang Blessing Geschäftsführer



CS INSTRUMENTS GmbH & Co. KG

Zindelsteiner Str. 15 | 78052 VS-Tannheim | GERMANY

Tel. +49 7705 978 99 0 | info@cs-instruments.com

www.cs-instruments.com